

45823

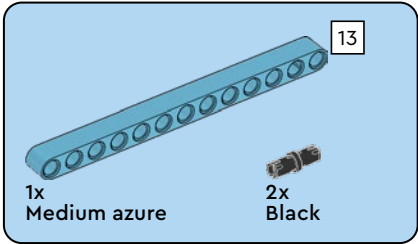

1

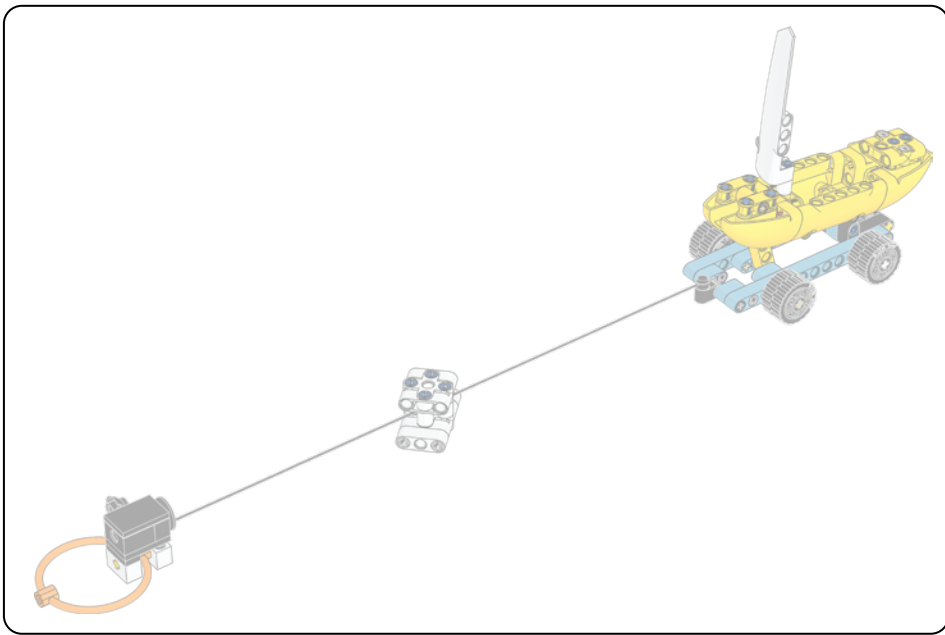
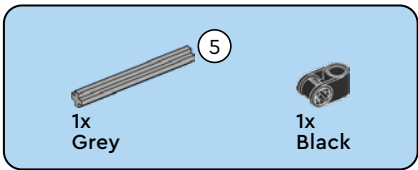
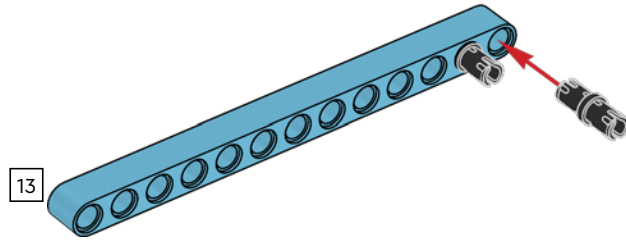

2

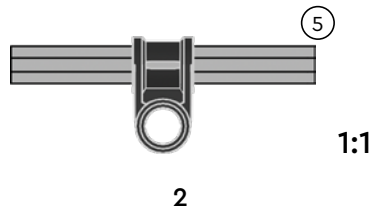

1:1

1x  
Red

3

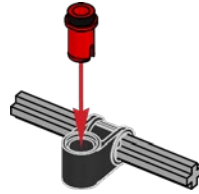

2x  
Black

2x  
Medium azure

4

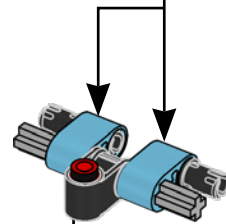
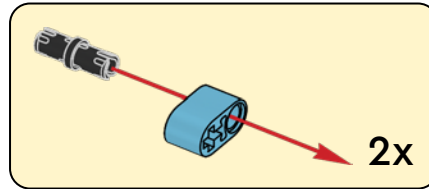

5

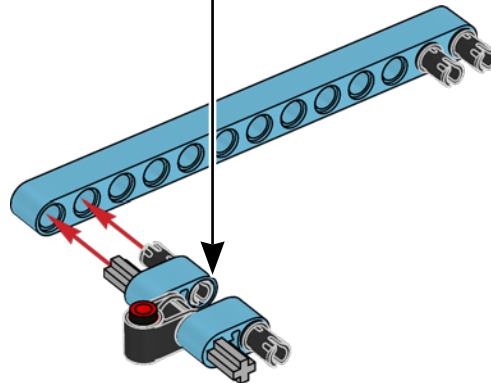

3

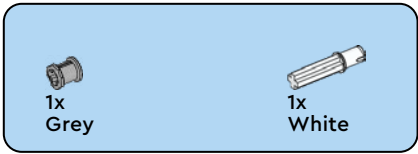

6

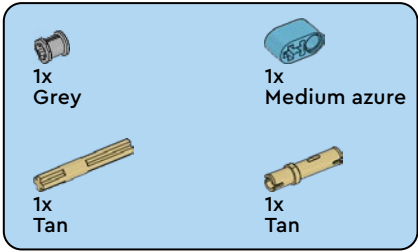
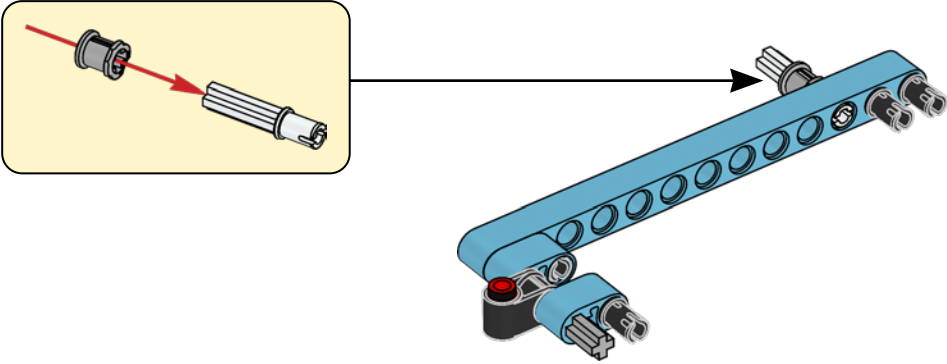

7

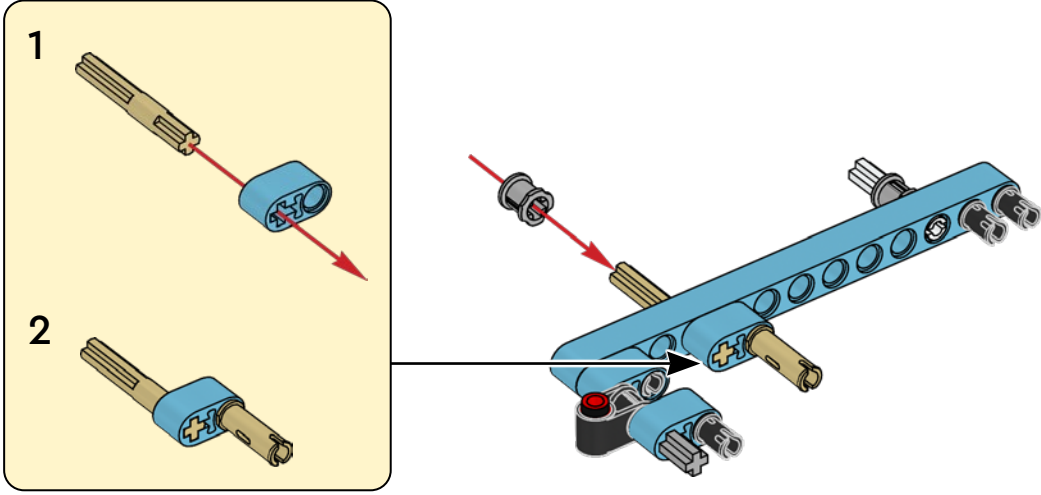

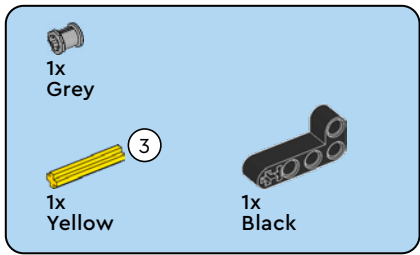

8

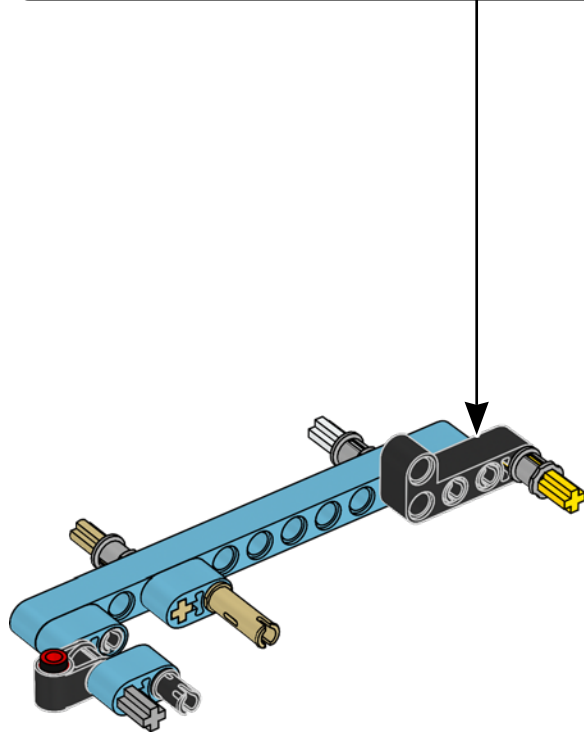
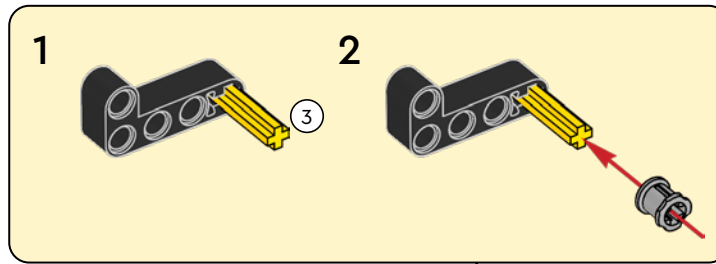

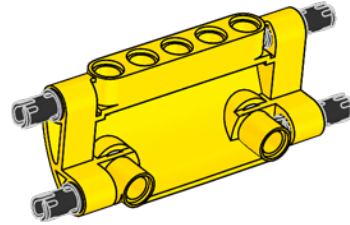
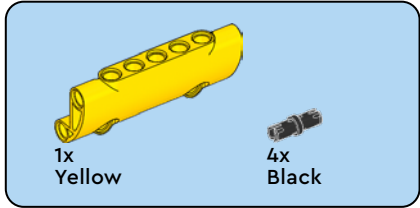
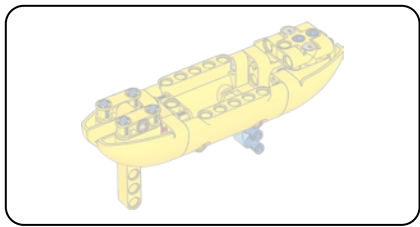

9

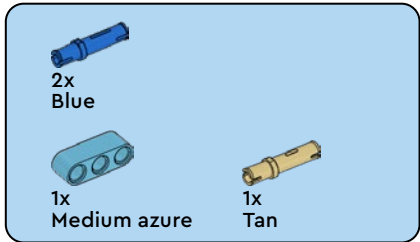

10

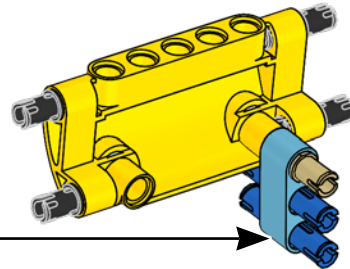
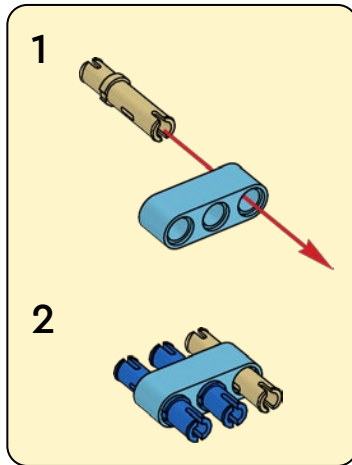

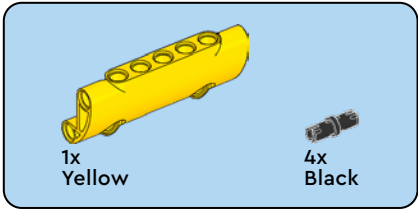

11

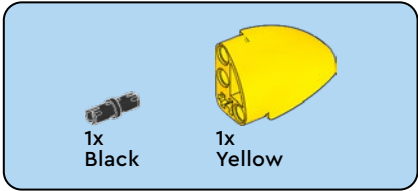
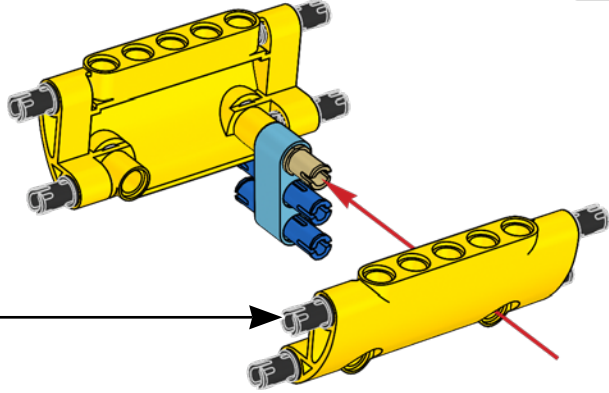
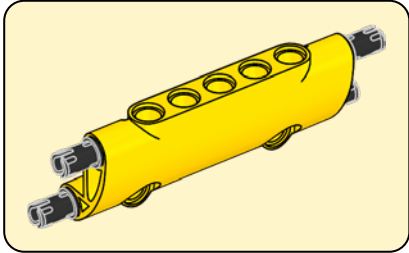

12

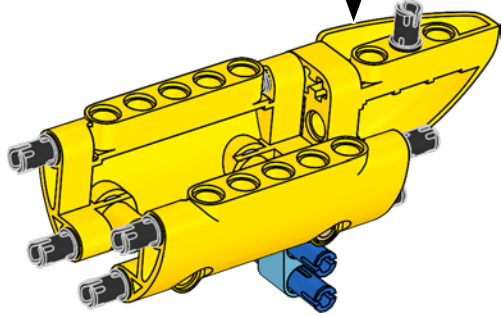
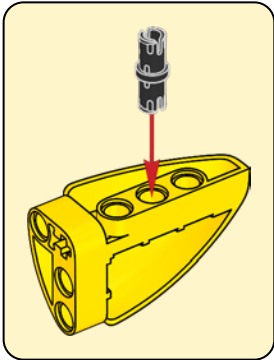

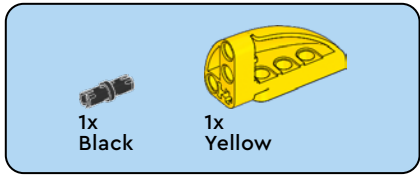

13

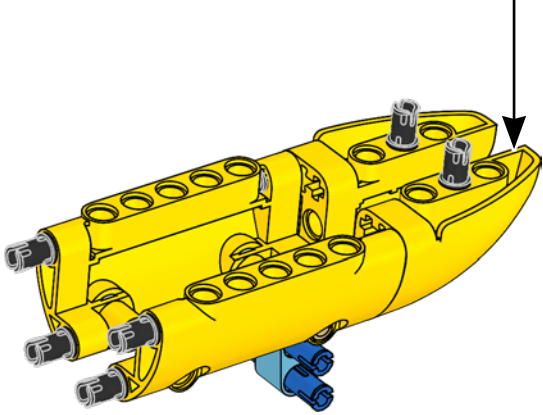
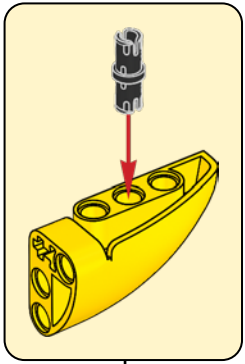



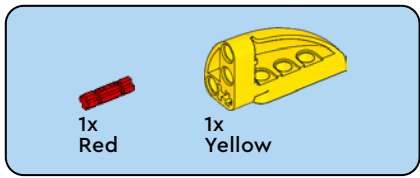

14

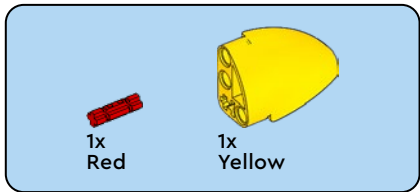
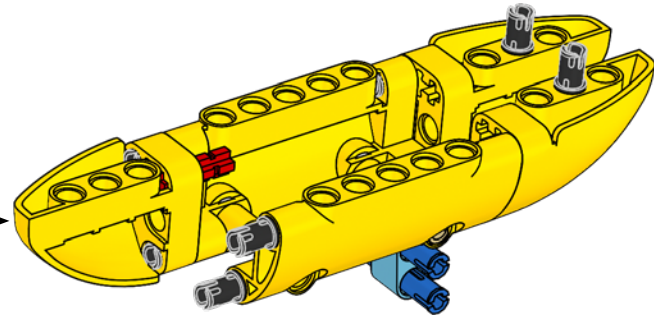
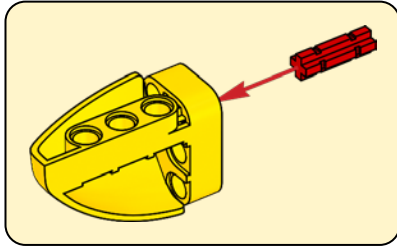

15

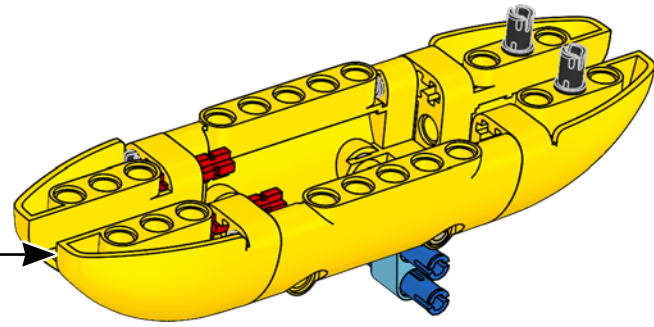
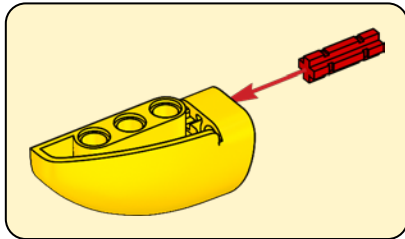

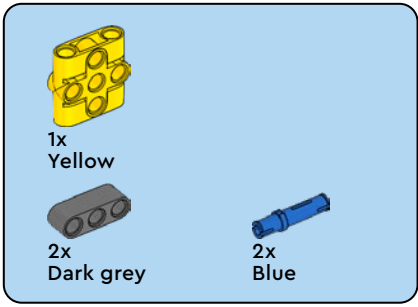

16

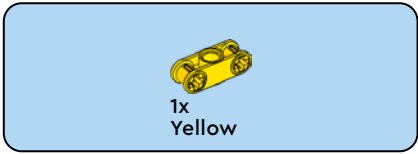
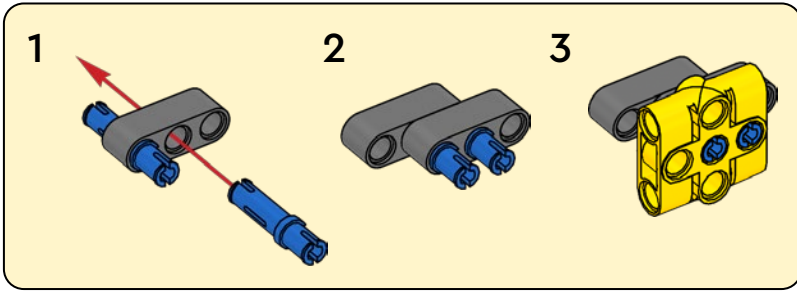

17

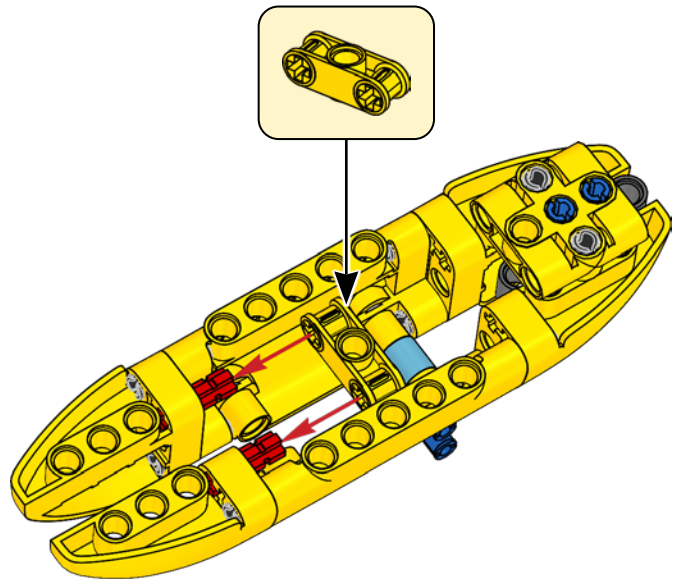
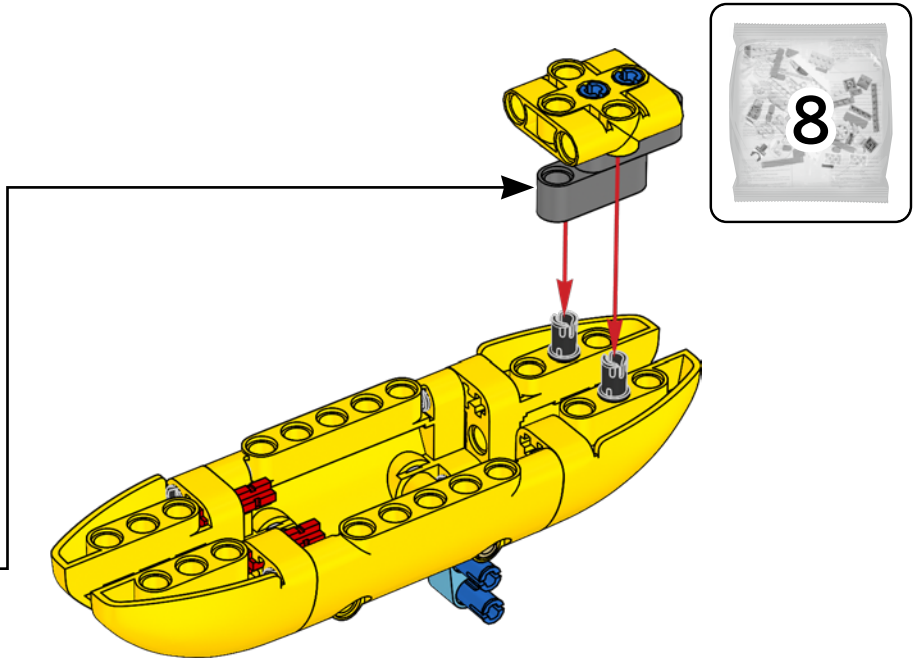

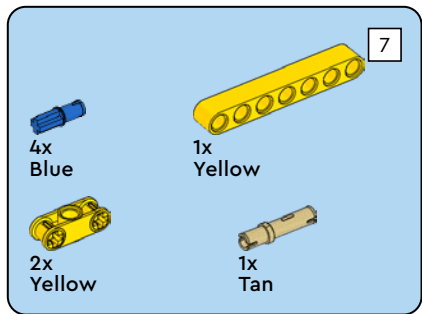

18

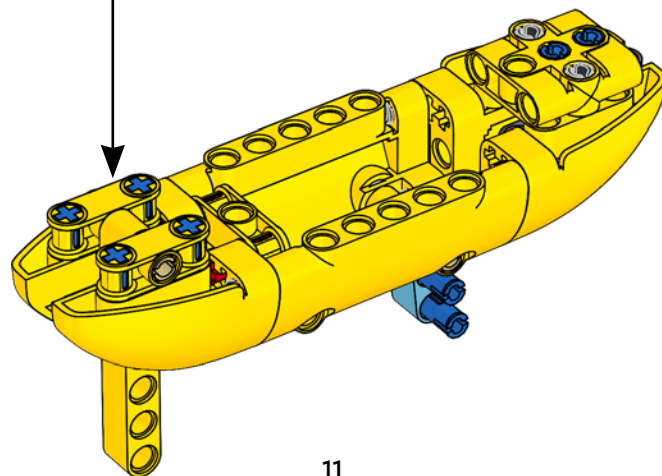
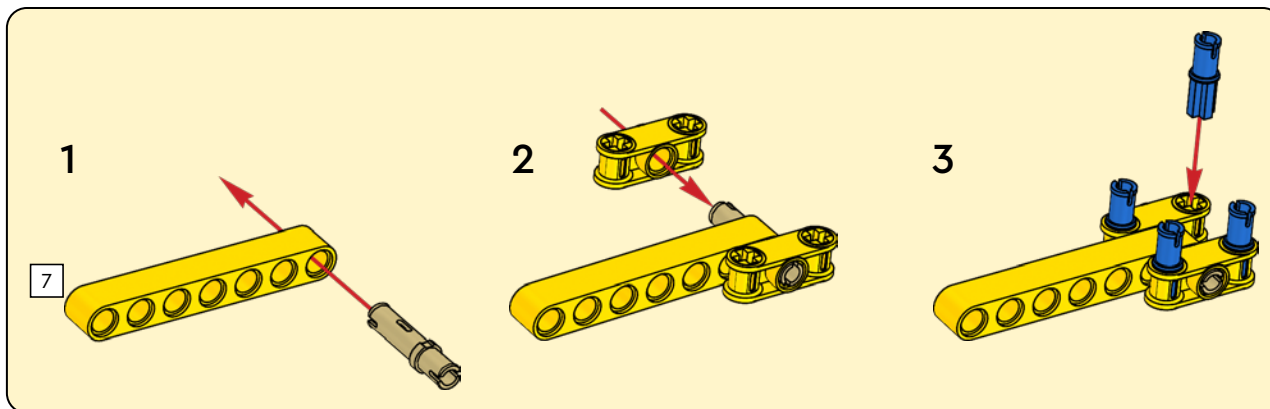

19

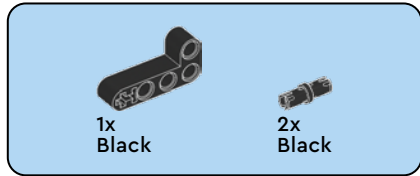
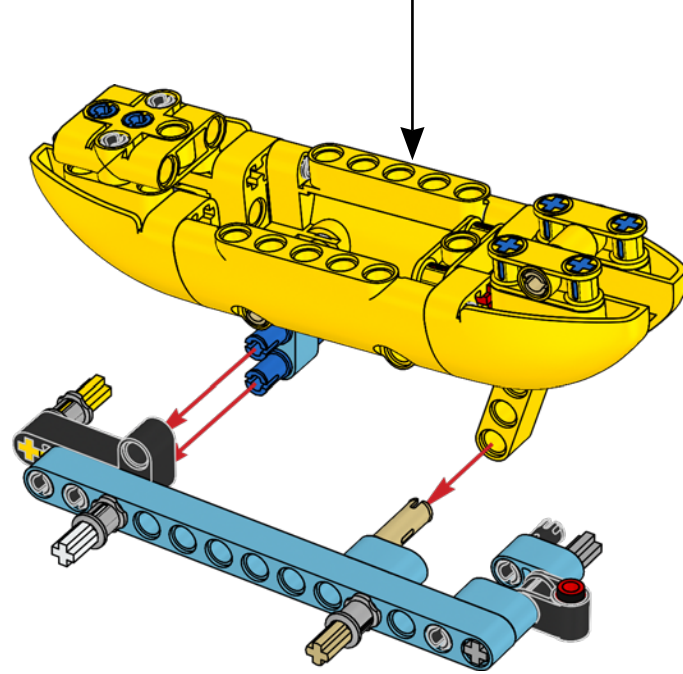

20

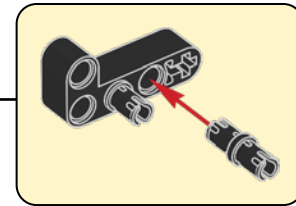
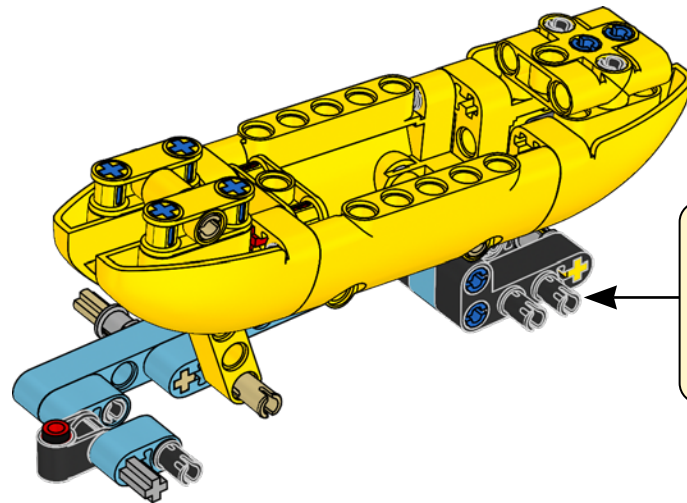
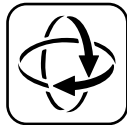

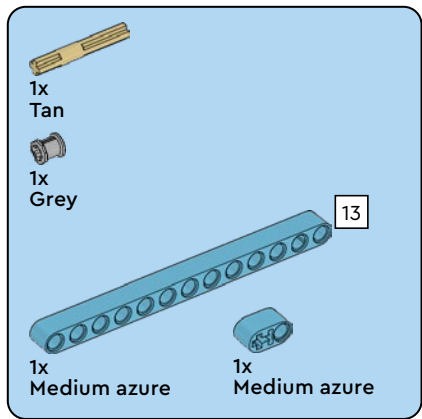

21

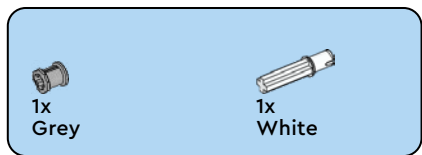
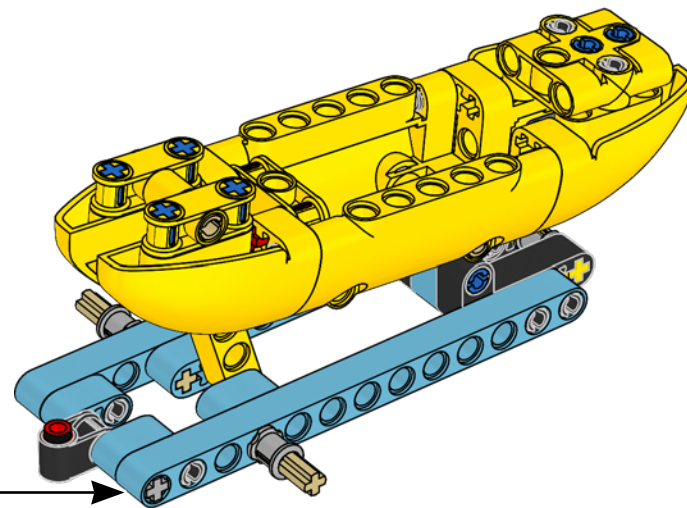
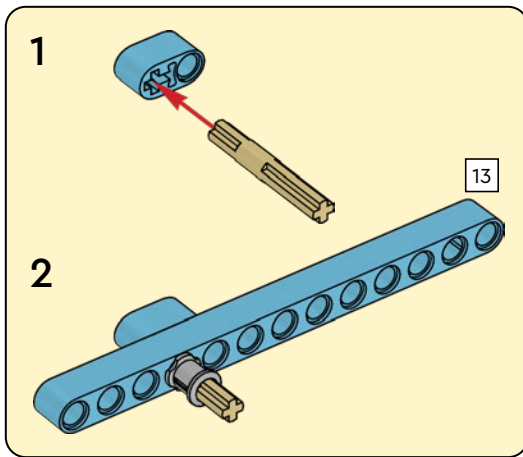

22

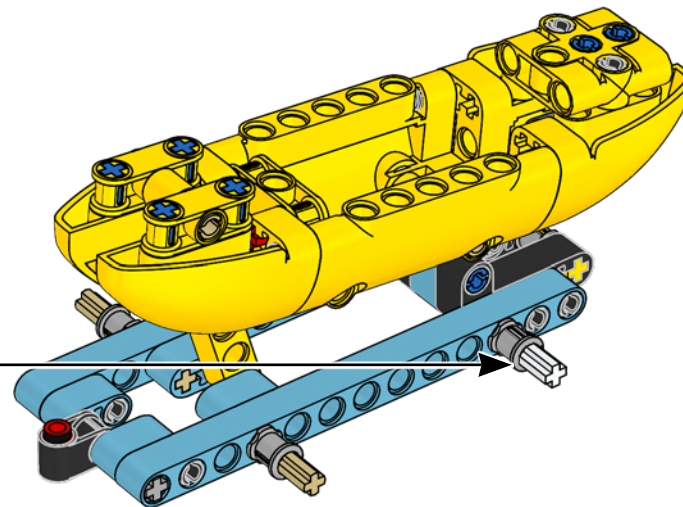
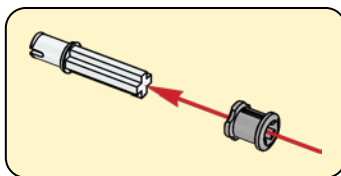

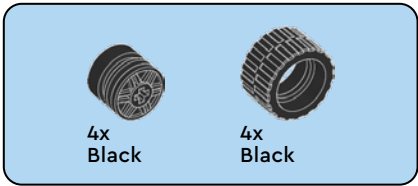

23

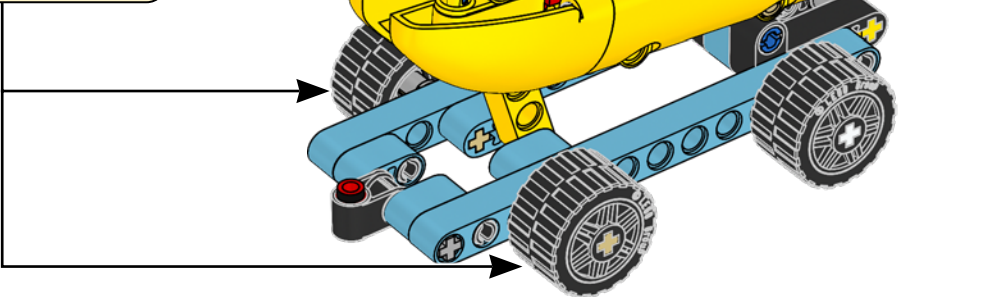
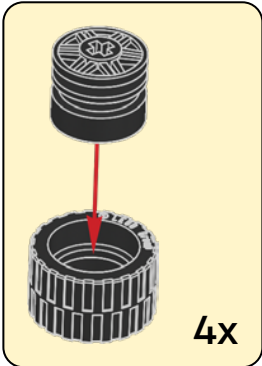

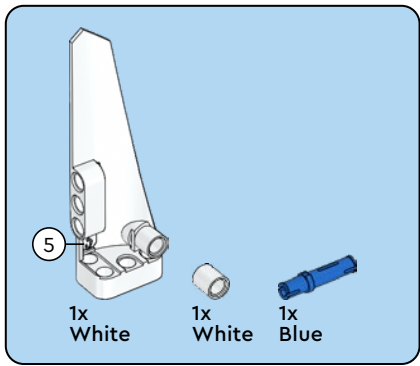

24

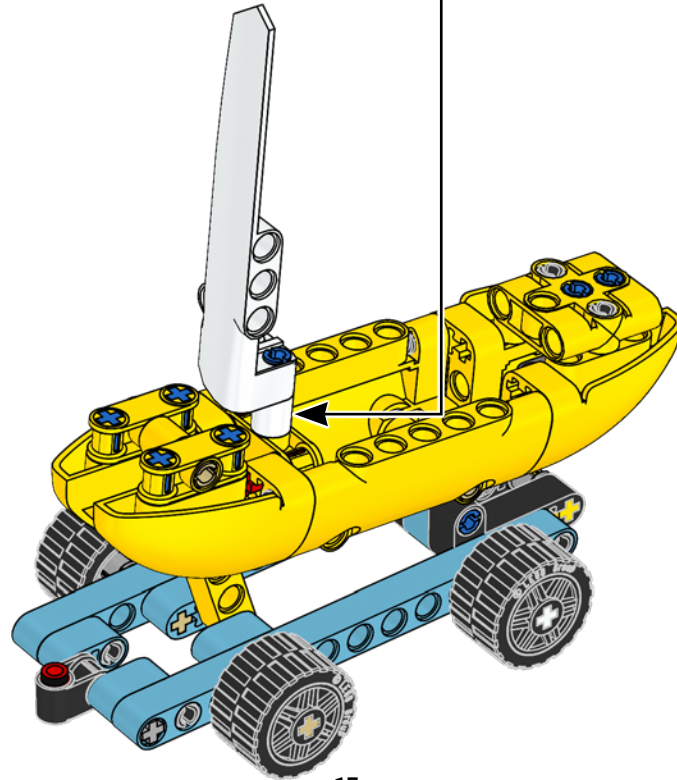
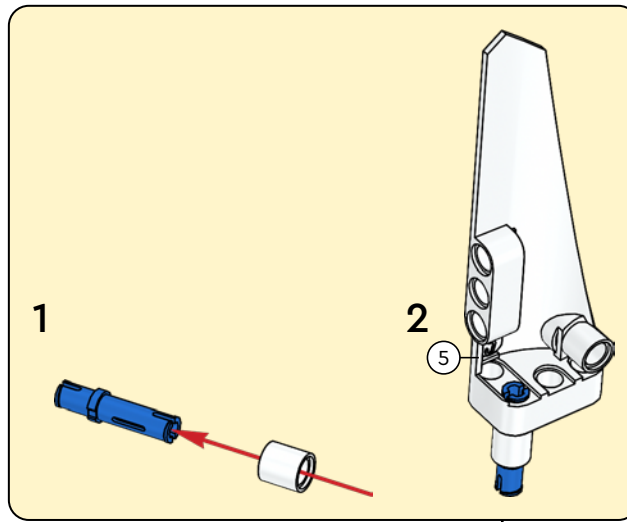

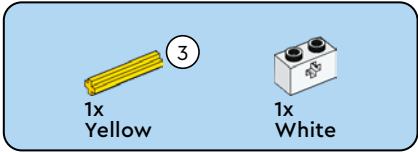
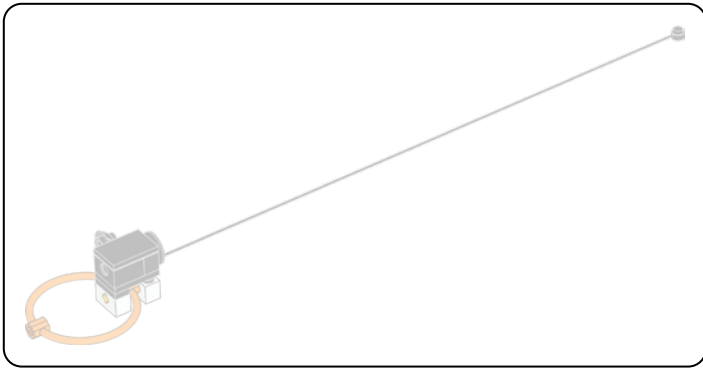

25

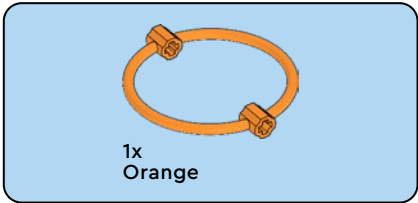
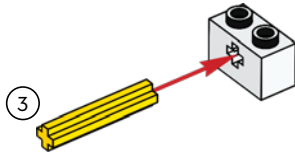

26

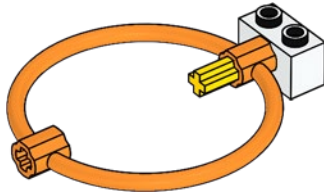





1x  
White

27

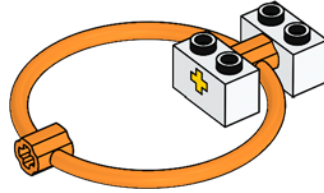

1x  
Black

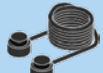

1x  
Black



1x  
Black

28

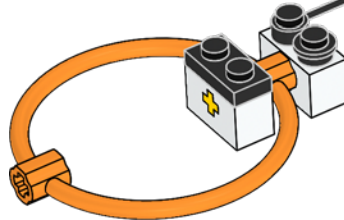

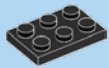

1x  
Black

29

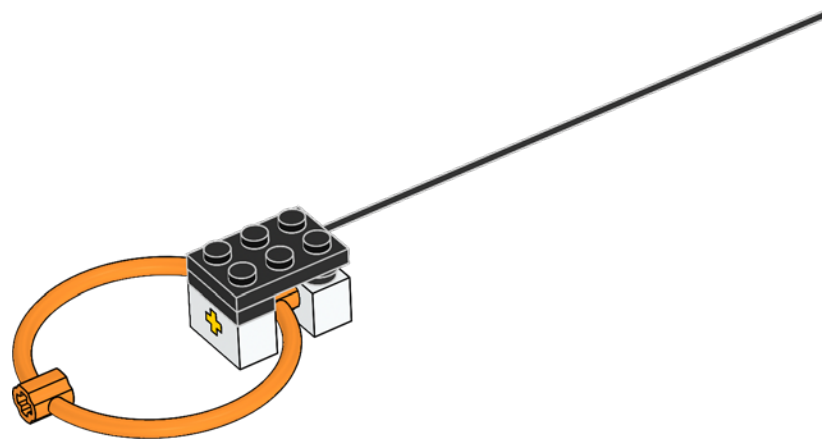

1x  
Black



1x  
Black

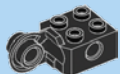

1x  
Black

30

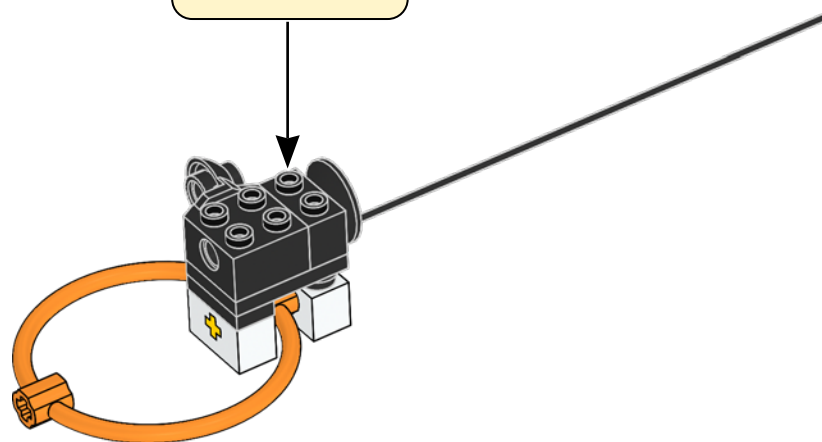
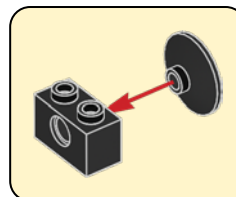

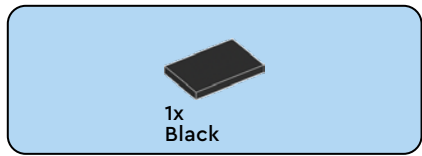

31

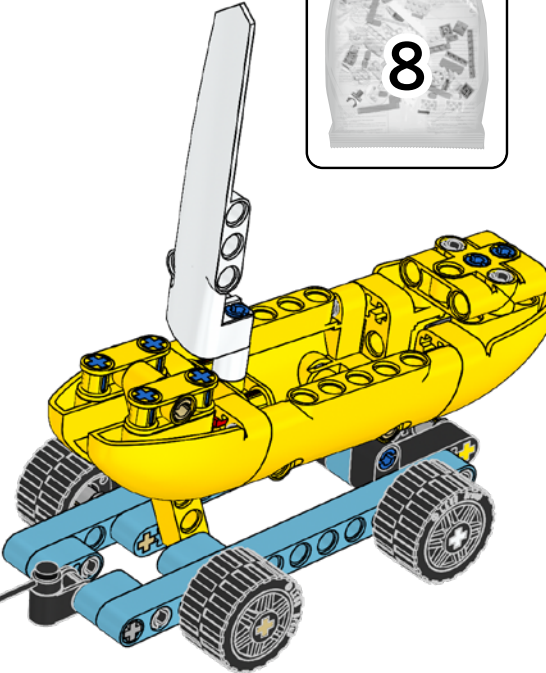
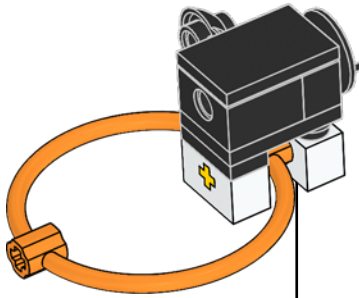

32

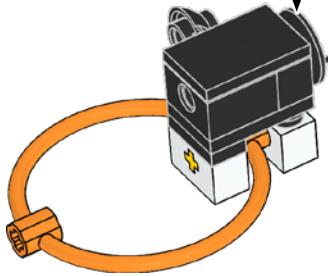

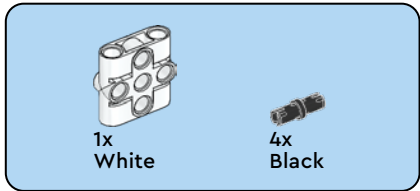
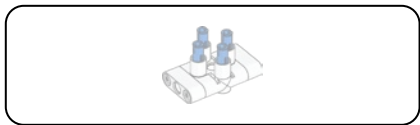

33

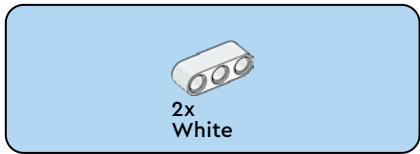
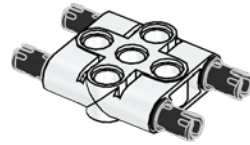

34

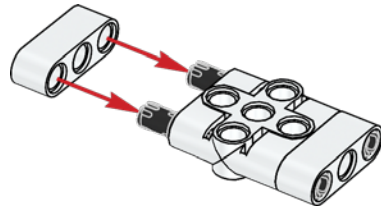

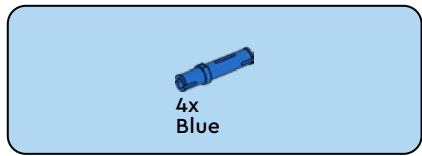

35

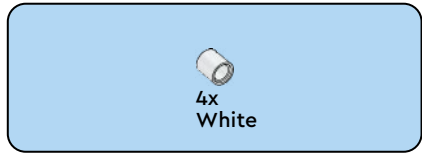
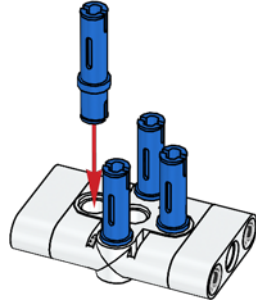

36

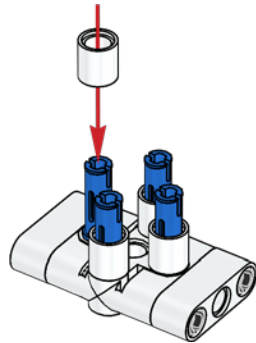

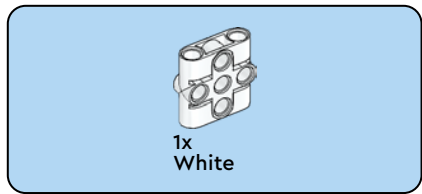

37

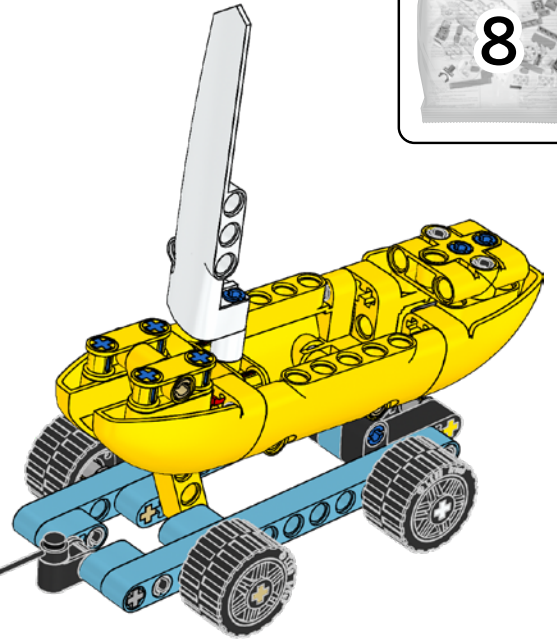
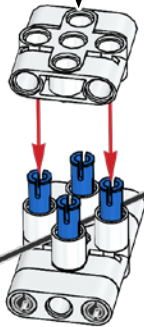
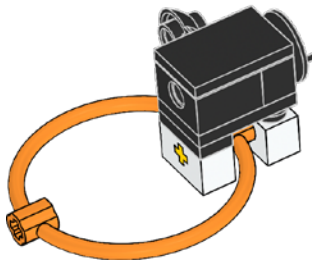

LEGO and the LEGO logo are trademarks of the/son des marques de commerce du/son marcas registradas de LEGO Group.  
©2023 The LEGO Group.

FIRST® is a registered trademark of For Inspiration and Recognition of Science and Technology (FIRST). LEGO® is a registered trademark of the LEGO Group. FIRST® LEGO® League and MASTERPIECE™ are jointly held trademarks of FIRST and the LEGO Group.  
©2023 FIRST and the LEGO Group. All rights reserved.